

# Elite 8 2015 January 10-11 Montréal 180 Women/Femmes -48kg

Competitors/Compétiteurs: 5

## Competitors/Compétiteurs

#	Name/Nom	Club	1	2	3	4	5	W/G	Pts	Pos
1	BESSION Marie	QC		10	10	10		3	30	1
2	MORGAN Erin	AB			10	10	5	3	25	2
3	KAEGI Lorena	MB				10	10	2	20	3
4	THIFFAULT Laurence	QC						0	0	5
5	SHEFFIELD Lea	ON	10			10		2	20	3

## Matches/Matches

Match	White/Blanc			Blue/Bleu	Res/Rés	Tim/Tmp	Code
A-5	THIFFAULT Laurence	4	5	SHEFFIELD Lea	0 - 10	3:14	IPO
A-6	BESSION Marie	1	2	MORGAN Erin	10 - 0	3:28	HAN
A-25	KAEGI Lorena	3	4	THIFFAULT Laurence	10 - 0	1:06	WIP
A-26	BESSION Marie	1	5	SHEFFIELD Lea	0 - 10	0:32	IPO
A-39	MORGAN Erin	2	3	KAEGI Lorena	10 - 0	0:47	IPO
A-40	BESSION Marie	1	4	THIFFAULT Laurence	10 - 0	0:52	IPO
A-52	KAEGI Lorena	3	5	SHEFFIELD Lea	10 - 0	2:29	WIP
A-53	MORGAN Erin	2	4	THIFFAULT Laurence	10 - 0	1:30	IPO
A-64	BESSION Marie	1	3	KAEGI Lorena	10 - 0	1:09	IPO
A-65	MORGAN Erin	2	5	SHEFFIELD Lea	5 - 0	4:00	YUK

## Results/Résultats

Pos	Name/Nom
1	BESSION Marie, QC
2	MORGAN Erin, AB
3	KAEGI Lorena, MB
3	SHEFFIELD Lea, ON

# Elite 8 2015 January 10-11 Montréal 180 Women/Femmes -52kg

Competitors/Compétiteurs: 10

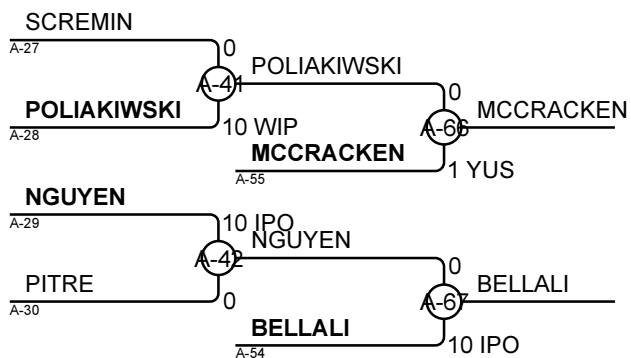
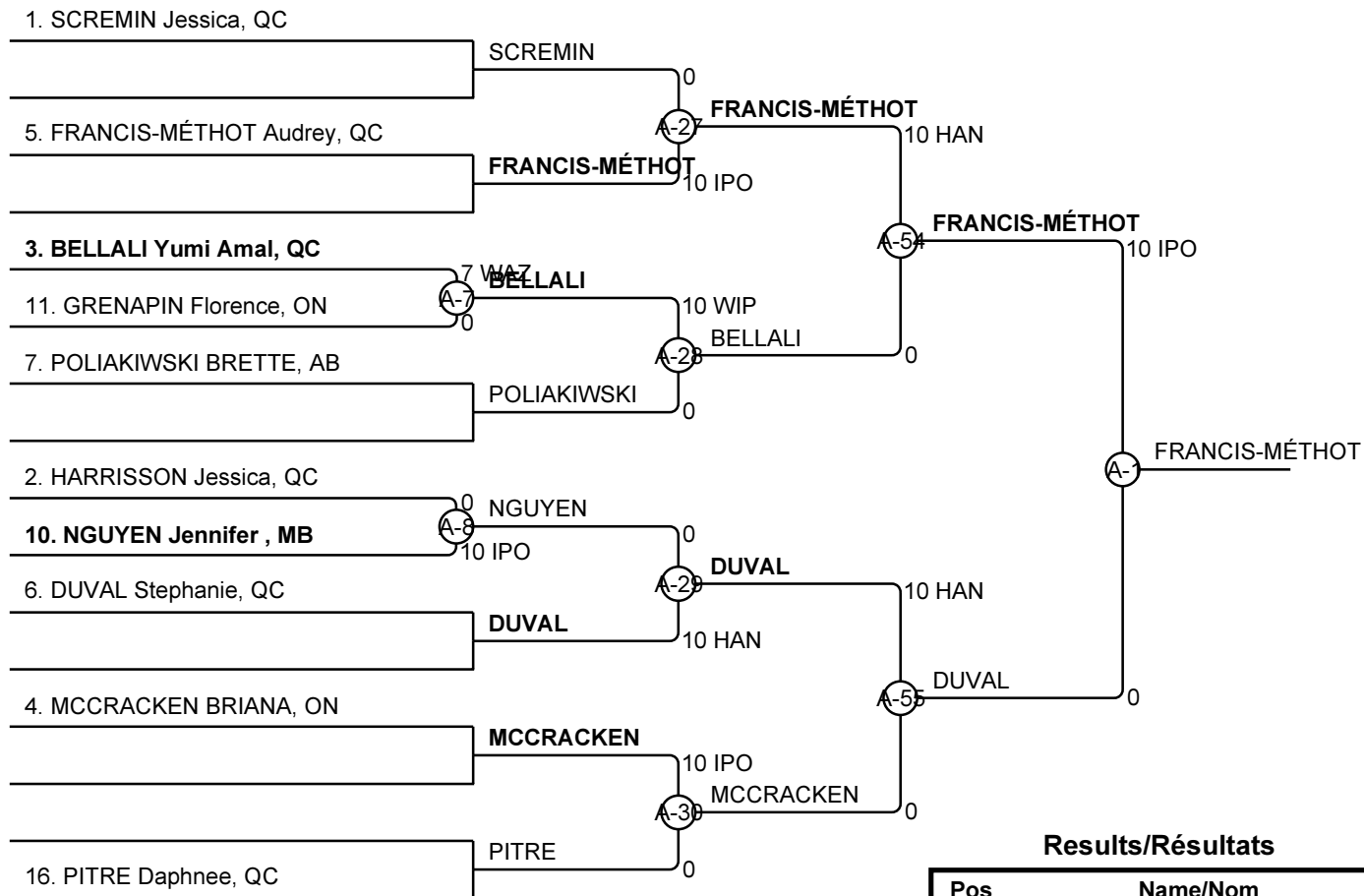

## Results/Résultats

Pos	Name/Nom
1	FRANCIS-MÉTHOT Audrey, QC
2	DUVAL Stephanie, QC
3	MCCRACKEN BRIANA, ON
3	BELLALI Yumi Amal, QC
5	POLIAKIWSKI BRETTE, AB
5	NGUYEN Jennifer, MB
7	SCREMIN Jessica, QC
7	PITRE Daphnee, QC

# Elite 8 2015 January 10-11 Montréal 180 Women/Femmes -57kg

Competitors/Compétiteurs: 8

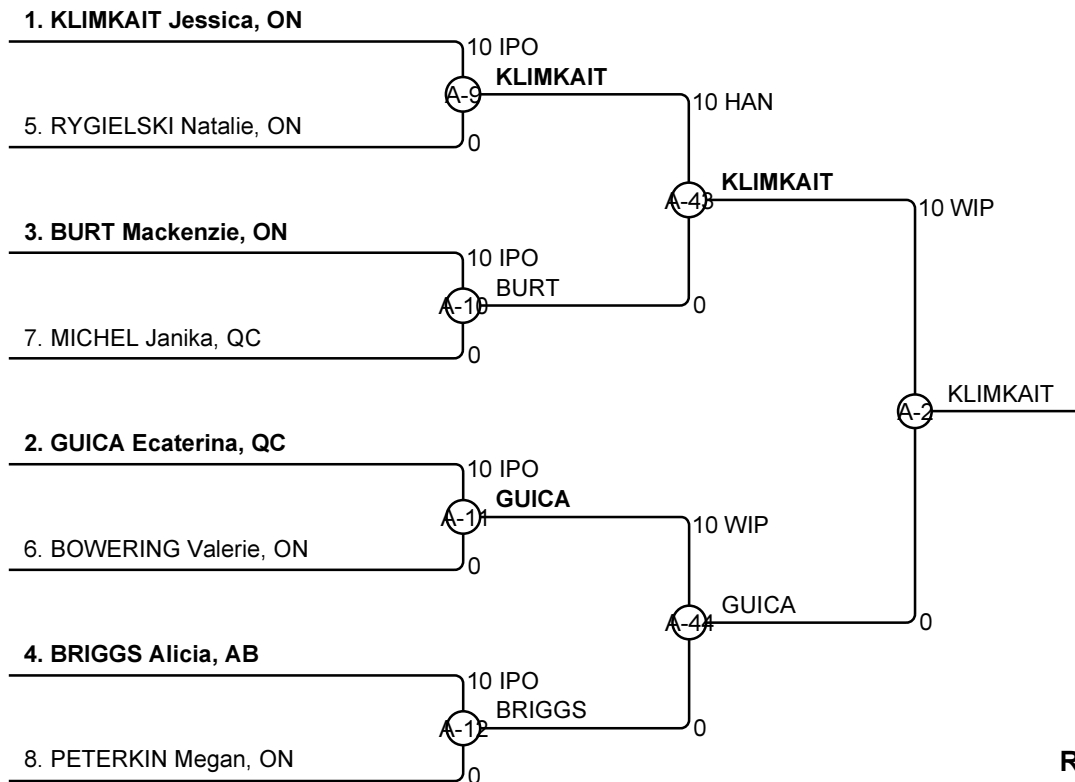

## Results/Résultats

Pos	Name/Nom
1	KLIMKAIT Jessica, ON
2	GUICA Ecaterina, QC
3	BRIGGS Alicia, AB
3	BURT Mackenzie, ON
5	MICHEL Janika, QC
5	PETERKIN Megan, ON
7	RYGIELSKI Natalie, ON
7	BOWERING Valerie, ON

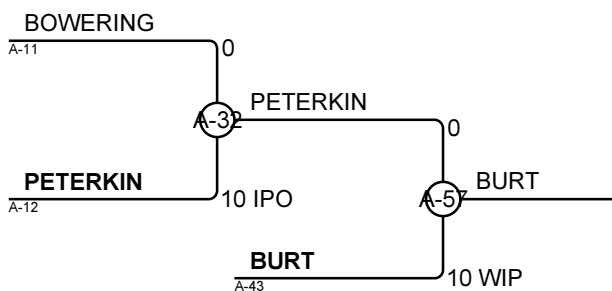
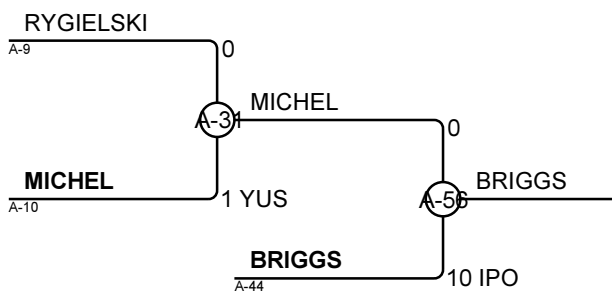

# Elite 8 2015 January 10-11 Montréal 180 Women/Femmes -63kg

Competitors/Compétiteurs: 8

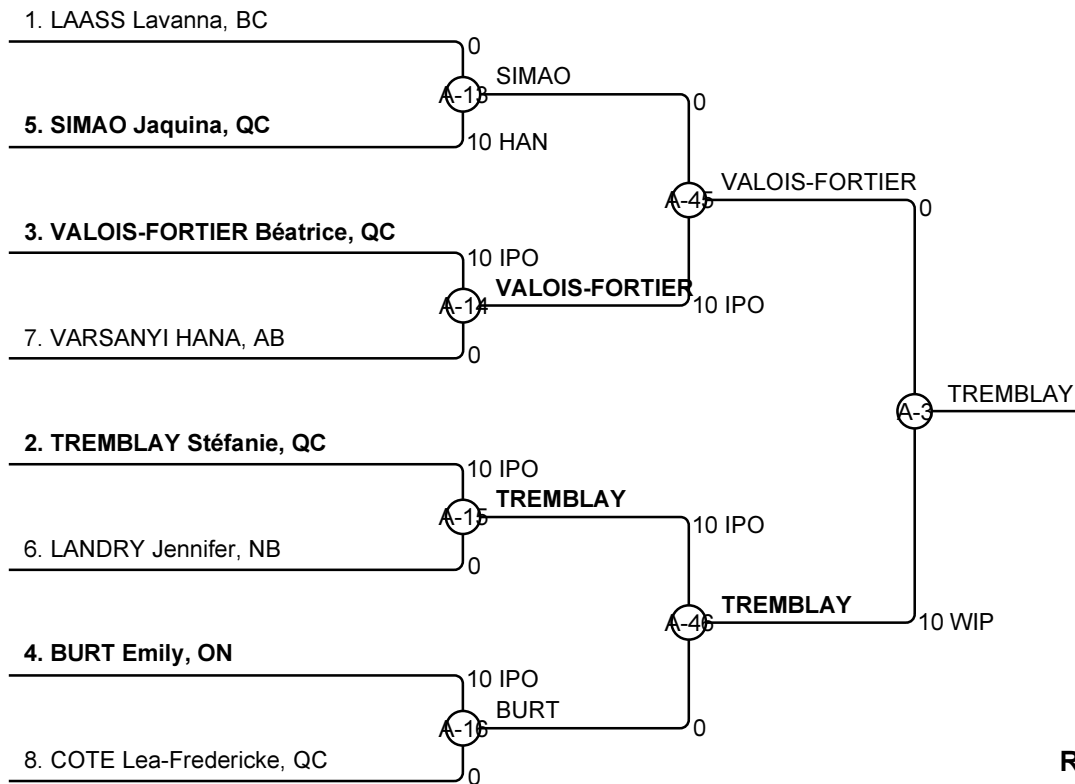

## Results/Résultats

Pos	Name/Nom
1	TREMBLAY Stéfanie, QC
2	VALOIS-FORTIER Béatrice, QC
3	BURT Emily, ON
3	SIMAO Jaquina, QC
5	VARSAANYI HANA, AB
5	COTE Lea-Fredericke, QC
7	LAASS Lavanna, BC
7	LANDRY Jennifer, NB

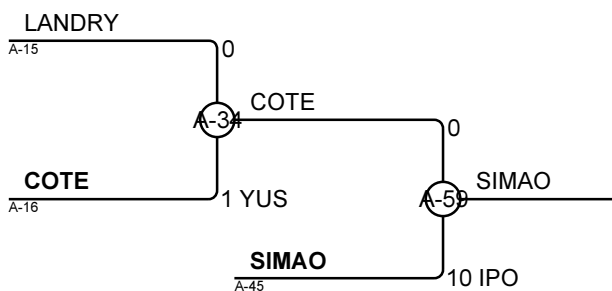
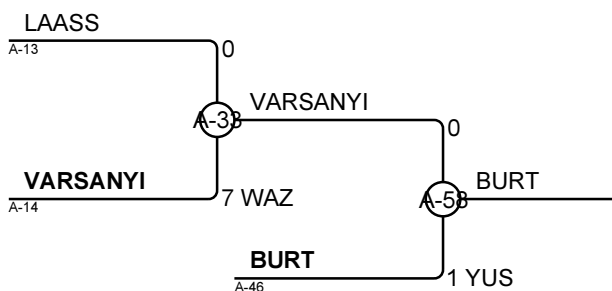

# Elite 8 2015 January 10-11 Montréal 180 Women/Femmes -70kg

Competitors/Compétiteurs: 7

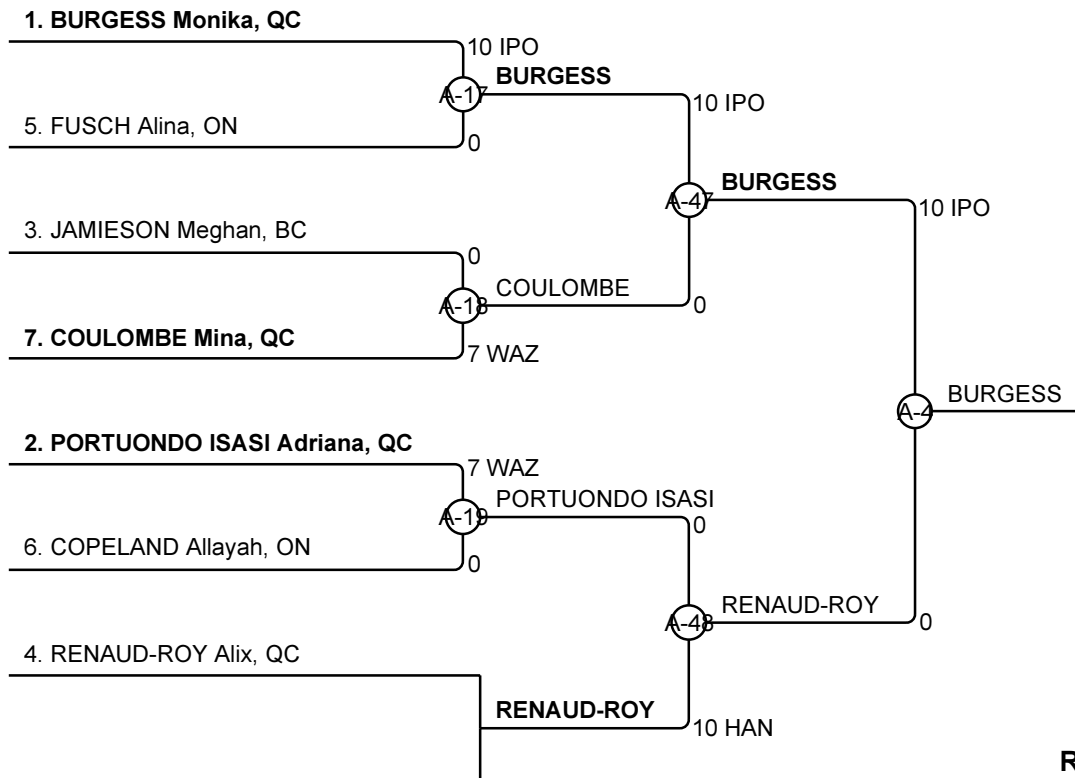

## Results/Résultats

Pos	Name/Nom
1	BURGESS Monika, QC
2	RENAUD-ROY Alix, QC
3	PORTUONDO ISASI Adriana, QC
3	COULOMBE Mina, QC
5	FUSCH Alina, ON
5	COPELAND Allayah, ON
7	JAMIESON Meghan, BC
7	

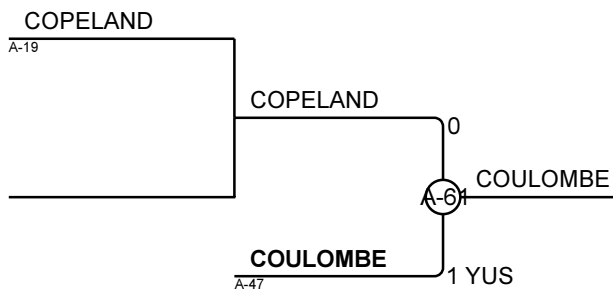
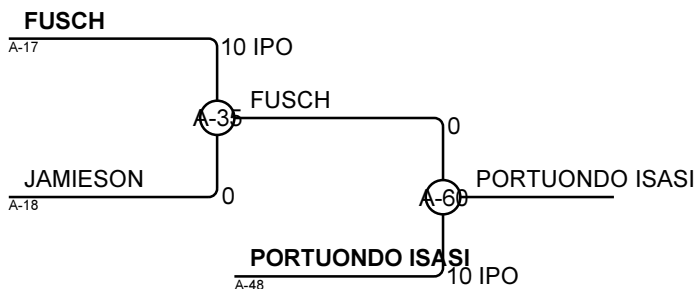

# Elite 8 2015 January 10-11 Montréal 180 Women/Femmes -78kg

Competitors/Compétiteurs: 3

## Competitors/Compétiteurs

#	Name/Nom	Club	1	2	3	W/G	Pts	Pos
1	HANKS Megan	BC				0	0	3
2	VAILLANCOURT Sophie	QC	5			1	5	2
3	PORTUONDO ISASI Ana Laura	QC	10	10		2	20	1

## Matches/Matches

Match	White/Blanc			Blue/Bleu	Res/Rés	Tim/Tmp	Code
A-20	HANKS Megan	1	2	VAILLANCOURT Sophie	0 - 5	4:00	YUK
A-36	HANKS Megan	1	3	PORTUONDO ISASI Ana Laura	0 - 10	3:34	IPO
A-49	VAILLANCOURT Sophie	2	3	PORTUONDO ISASI Ana Laura	0 - 10	1:56	IPO

## Results/Résultats

Pos	Name/Nom
1	PORTUONDO ISASI Ana Laura , QC
2	VAILLANCOURT Sophie, QC

# Elite 8 2015 January 10-11 Montréal 180 Men/Hommes -100kg

Competitors/Compétiteurs: 5

## Competitors/Compétiteurs

#	Name/Nom	Club	1	2	3	4	5	W/G	Pts	Pos
1	PROULX Ryan	QC				7		1	7	3
2	ROMANOV Andriy	BC	10		10	10	10	4	40	1
3	DUDAREV Vadim	ON	10			10		2	20	3
4	JAMIESON Tavis	BC						0	0	5
5	DESCHENES Marc	QC	10		10	10		3	30	2

## Matches/Matches

Match	White/Blanc			Blue/Bleu	Res/Rés	Tim/Tmp	Code
B-18	JAMIESON Tavis	4	5	DESCHENES Marc	0 - 10	0:15	IPO
B-19	PROULX Ryan	1	2	ROMANOV Andriy	0 - 10	1:46	WIP
B-31	<b>DUDAREV Vadim</b>	3	4	JAMIESON Tavis	10 - 0	3:11	HAN
B-32	PROULX Ryan	1	5	DESCHENES Marc	0 - 10	0:41	IPO
B-43	<b>ROMANOV Andriy</b>	2	3	DUDAREV Vadim	10 - 0	3:06	HAN
B-44	<b>PROULX Ryan</b>	1	4	JAMIESON Tavis	7 - 0	5:00	WAZ
B-55	DUDAREV Vadim	3	5	DESCHENES Marc	0 - 10	0:44	IPO
B-56	<b>ROMANOV Andriy</b>	2	4	JAMIESON Tavis	10 - 0	0:35	IPO
B-61	PROULX Ryan	1	3	DUDAREV Vadim	0 - 10	1:08	IPO
B-62	<b>ROMANOV Andriy</b>	2	5	DESCHENES Marc	10 - 0	4:24	IPO

## Results/Résultats

Pos	Name/Nom
1	ROMANOV Andriy, BC
2	DESCHENES Marc, QC
3	DUDAREV Vadim, ON
3	PROULX Ryan, QC

# Elite 8 2015 January 10-11 Montréal 180 Men/Hommes -60kg

Competitors/Compétiteurs: 8

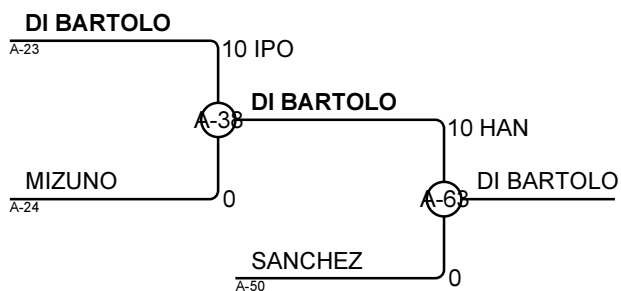
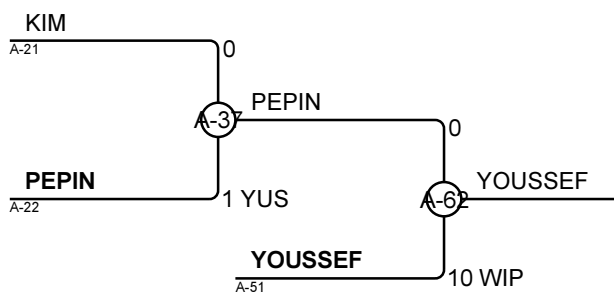
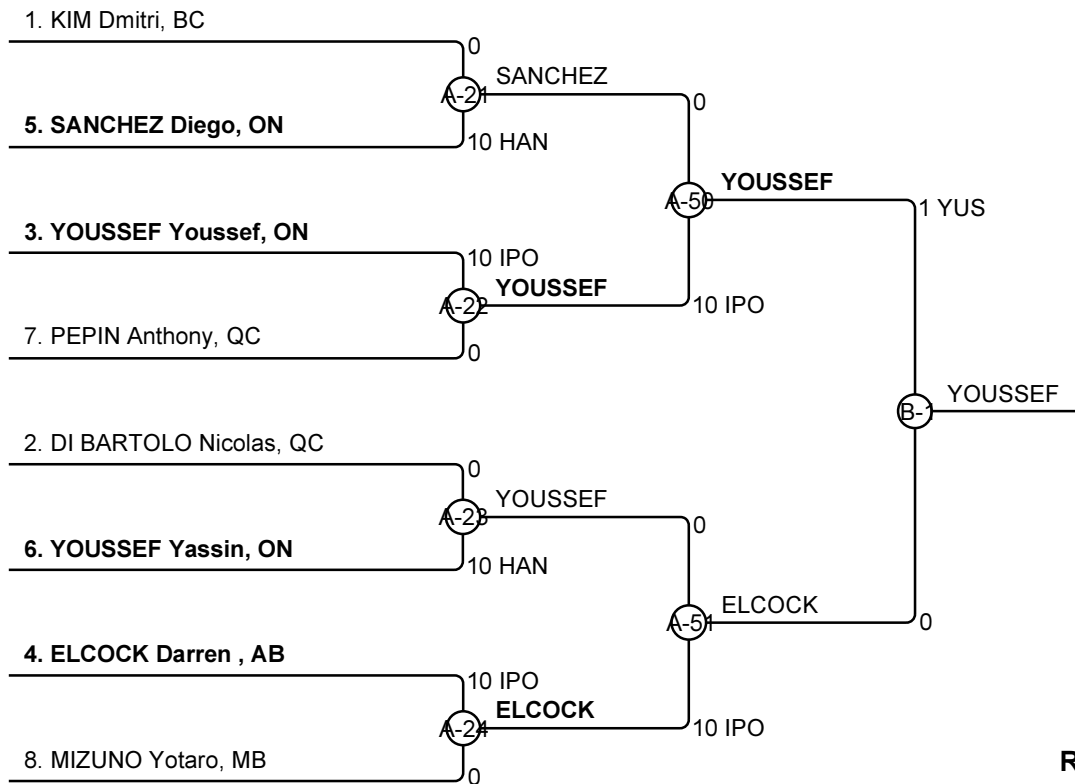

## Results/Résultats

Pos	Name/Nom
1	YOUSSEF Youssef, ON
2	ELCOCK Darren, AB
3	YOUSSEF Yassin, ON
3	DI BARTOLO Nicolas, QC
5	PEPIN Anthony, QC
5	SANCHEZ Diego, ON
7	KIM Dmitri, BC
7	MIZUNO Yotaro, MB



# Elite 8 2015 January 10-11 Montréal 180 Men/Hommes -66kg

Competitors/Compétiteurs: 8

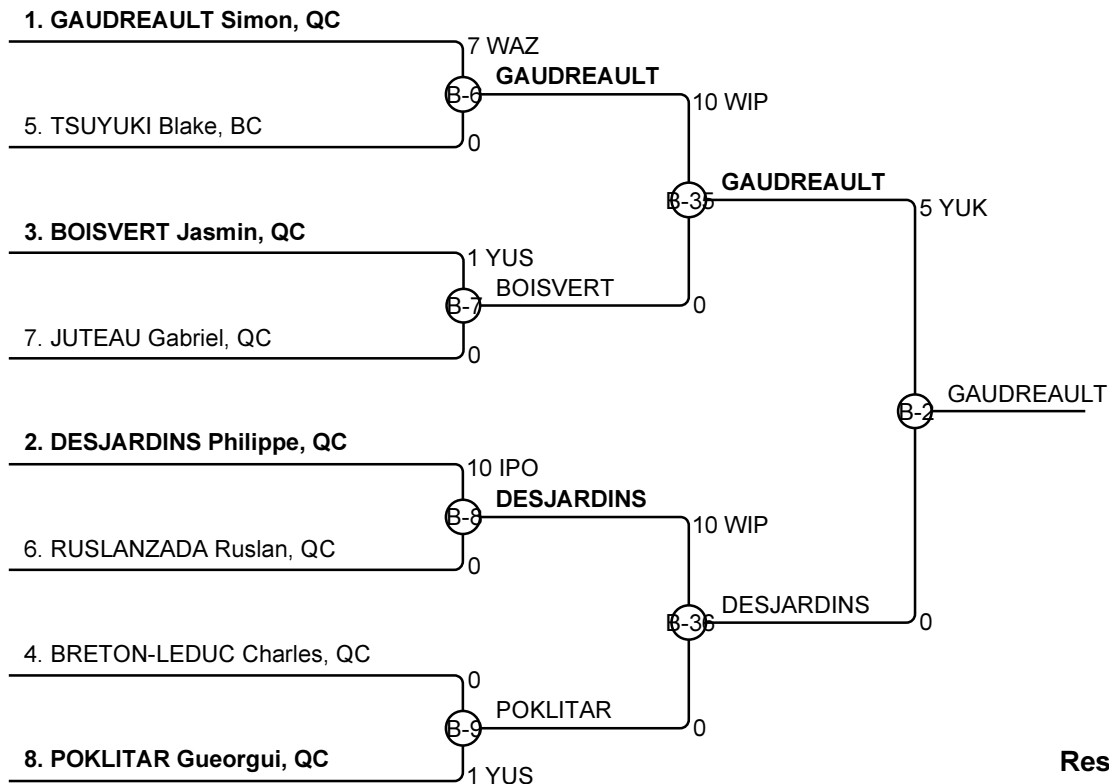

## Results/Résultats

Pos	Name/Nom
1	GAUDREAU Simon, QC
2	DESJARDINS Philippe, QC
3	POKLITAR Gueorgui, QC
3	BRETON-LEDUC Charles, QC
5	TSUYUKI Blake, BC
5	BOISVERT Jasmin, QC
7	JUTEAU Gabriel, QC
7	RUSLANZADA Ruslan, QC

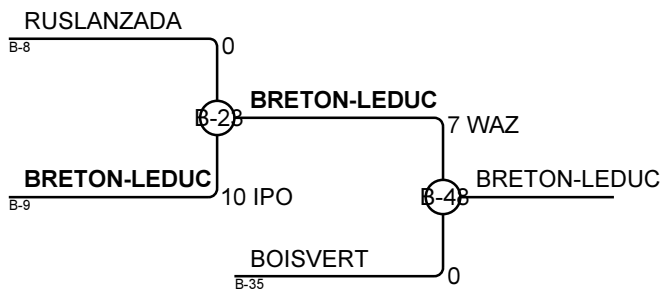
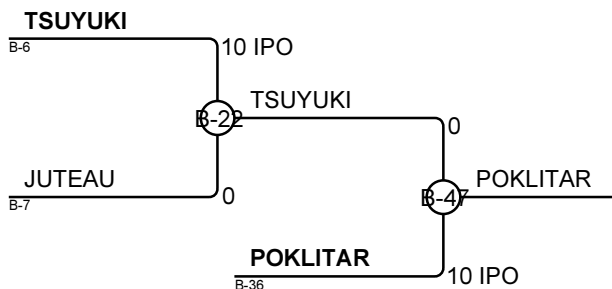

# Elite 8 2015 January 10-11 Montréal 180 Men/Hommes -73kg

Competitors/Compétiteurs: 9

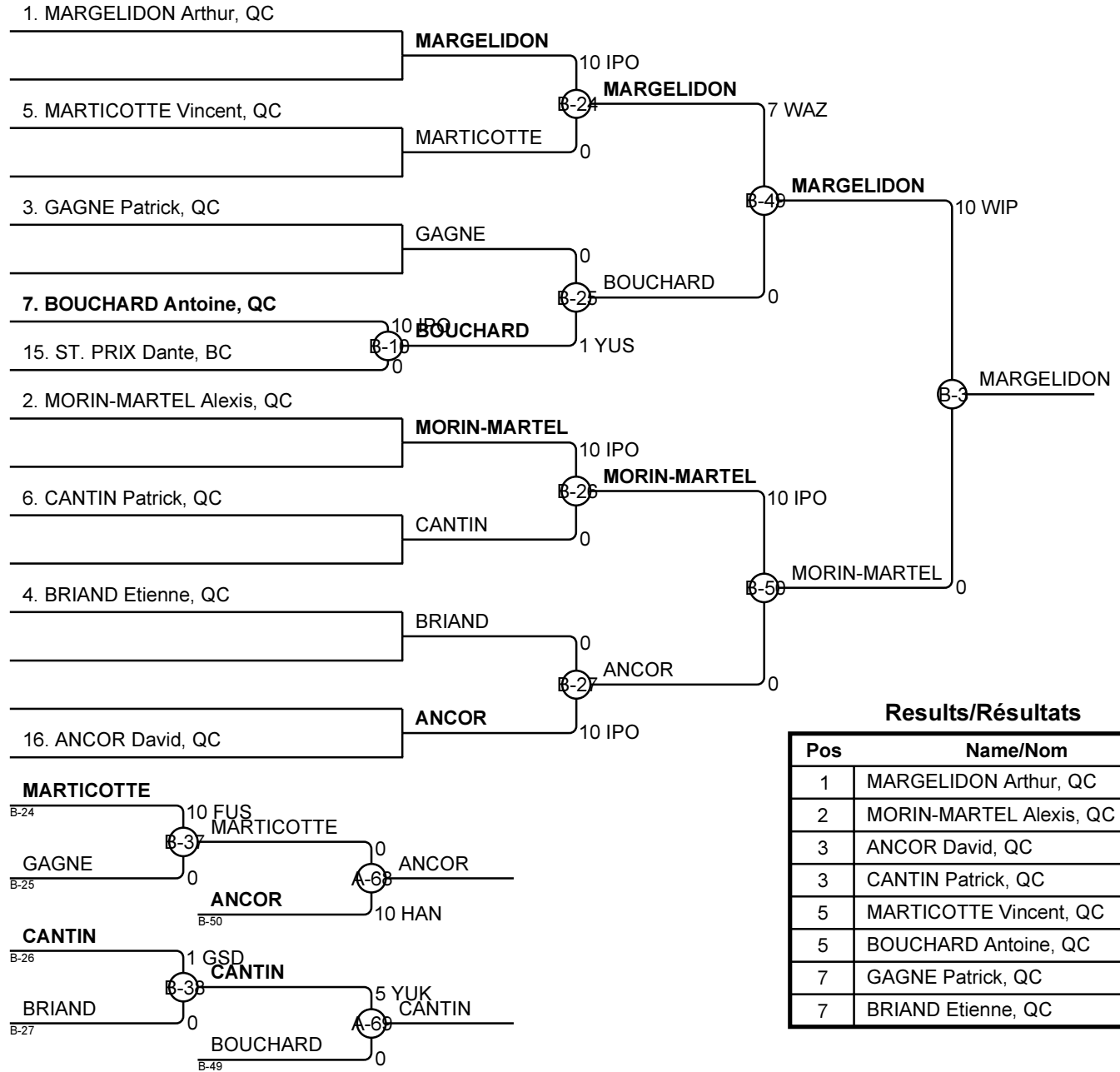

## Results/Résultats

Pos	Name/Nom
1	MARGELIDON Arthur, QC
2	MORIN-MARTEL Alexis, QC
3	ANCOR David, QC
3	CANTIN Patrick, QC
5	MARTICOTTE Vincent, QC
5	BOUCHARD Antoine, QC
7	GAGNE Patrick, QC
7	BRIAND Etienne, QC

# Elite 8 2015 January 10-11 Montréal 180 Men/Hommes -81kg

Competitors/Compétiteurs: 7

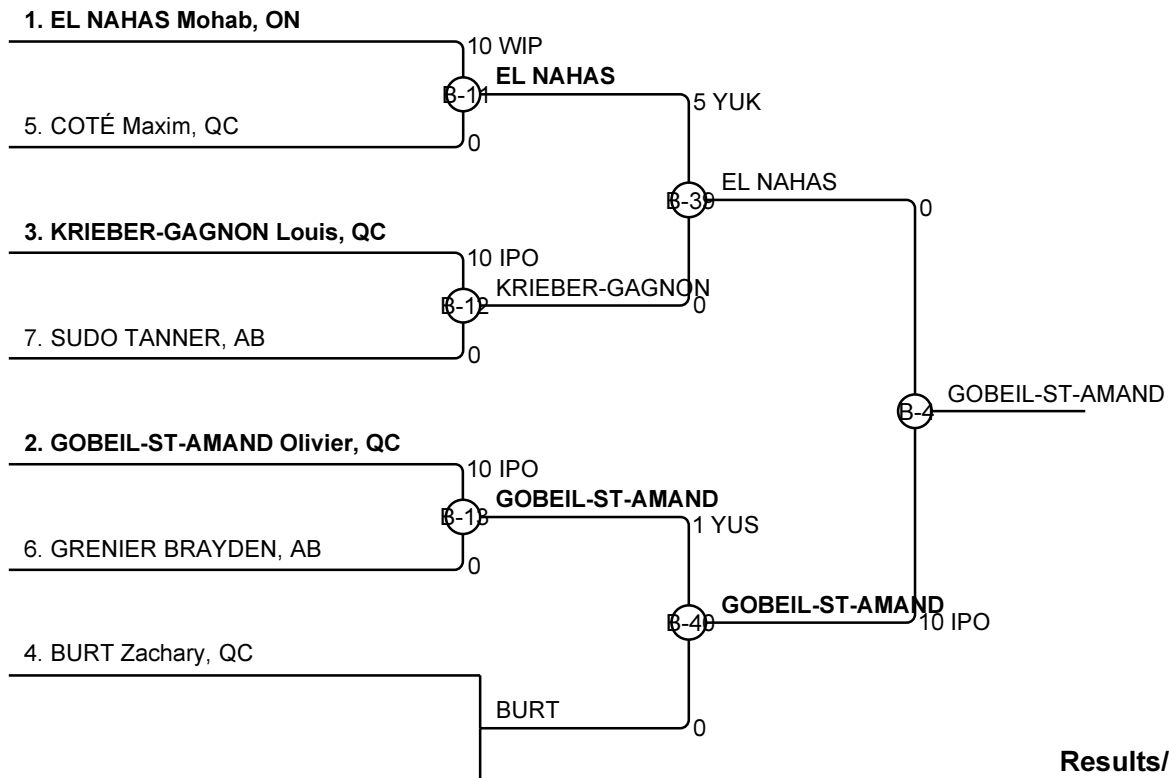

## Results/Résultats

Pos	Name/Nom
1	GOBEIL-ST-AMAND Olivier, QC
2	EL NAHAS Mohab, ON
3	BURT Zachary, QC
3	KRIEBER-GAGNON Louis, QC
5	COTÉ Maxim, QC
5	GRENIER BRAYDEN, AB
7	SUDO TANNER, AB
7	

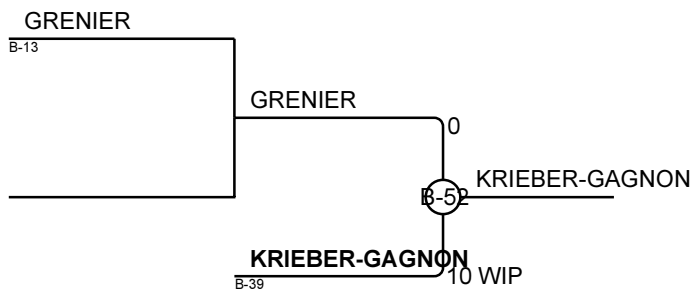
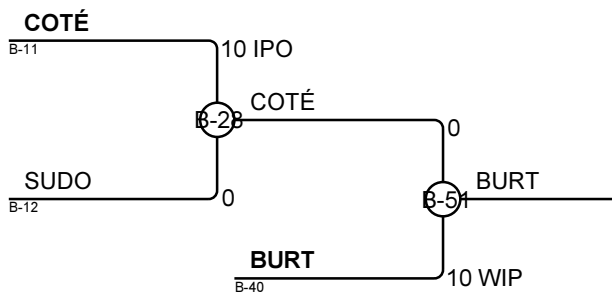

# Elite 8 2015 January 10-11 Montréal 180 Men/Hommes -90kg

Competitors/Compétiteurs: 8

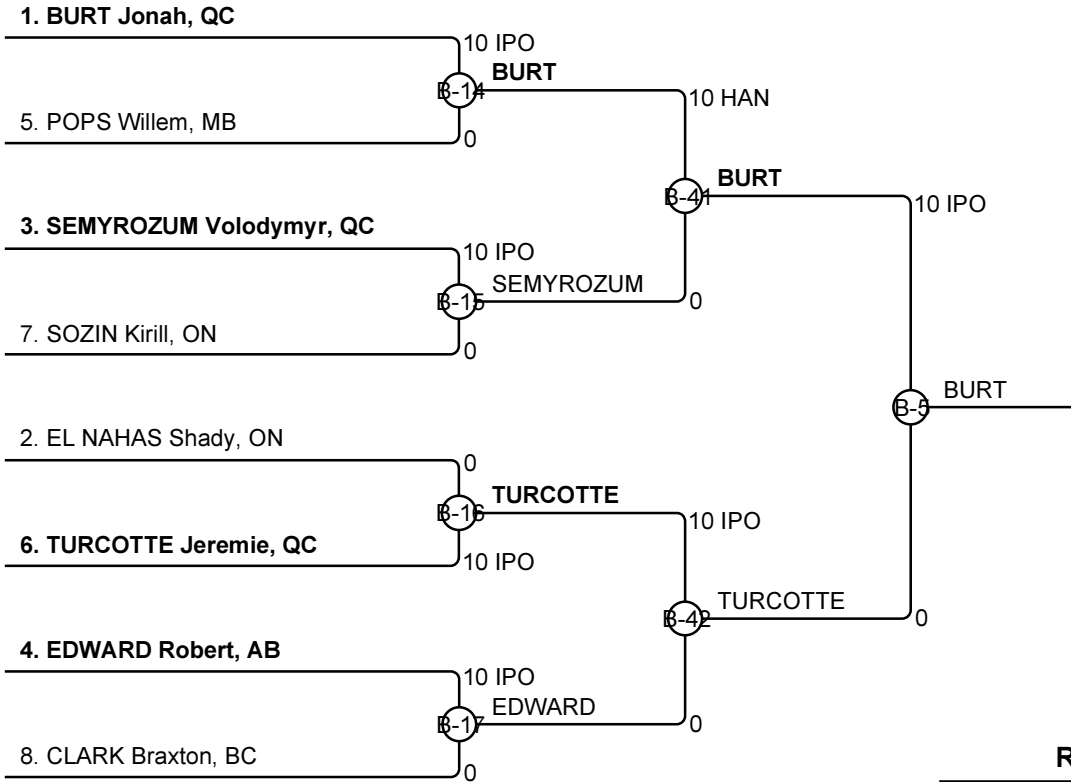

## Results/Résultats

Pos	Name/Nom
1	BURT Jonah, QC
2	TURCOTTE Jeremie, QC
3	EDWARD Robert, AB
3	EL NAHAS Shady, ON
5	SOZIN Kirill, ON
5	SEMYROZUM Volodymyr, QC
7	POPS Willem, MB
7	CLARK Braxton, BC

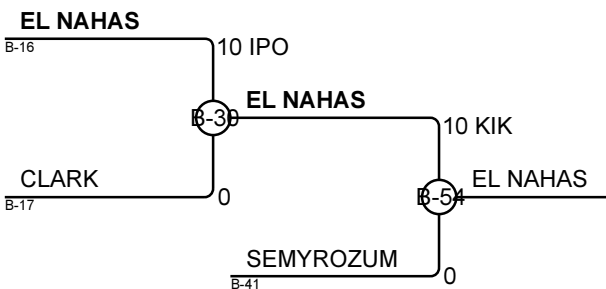
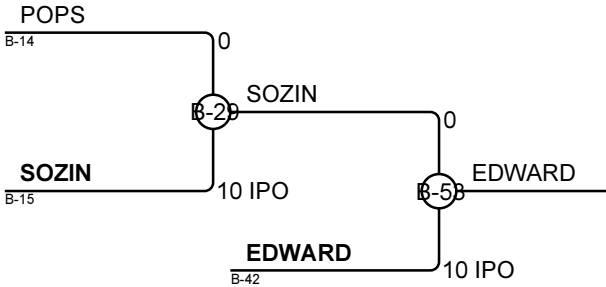

# Elite 8 2015 January 10-11 Montréal 180 Men/Hommes +100kg

Competitors/Compétiteurs: 5

## Competitors/Compétiteurs

#	Name/Nom	Club	1	2	3	4	5	W/G	Pts	Pos
1	SARENAC Nedjo	ON						0	0	5
2	RODRIGUEZ Ignacio	BC					10	1	10	3
3	MCMANUS James	NB		10		7		2	17	2
4	OUELLET Jean-Francois	QC		10				1	10	3
5	RYGIELSKI Martin	ON			10	10		2	20	1

## Matches/Matches

Match	White/Blanc			Blue/Bleu	Res/Rés	Tim/Tmp	Code
B-20	OUELLET Jean-Francois	4	5	RYGIELSKI Martin	0 - 10	2:31	WIP
B-21	SARENAC Nedjo	1	2	RODRIGUEZ Ignacio			
B-33	<b>MCMANUS James</b>	3	4	OUELLET Jean-Francois	7 - 0	5:00	WAZ
B-34	SARENAC Nedjo	1	5	RYGIELSKI Martin			
B-45	RODRIGUEZ Ignacio	2	3	<b>MCMANUS James</b>	0 - 10	4:10	WIP
B-46	SARENAC Nedjo	1	4	OUELLET Jean-Francois			
B-57	MCMANUS James	3	5	<b>RYGIELSKI Martin</b>	0 - 10	3:36	WIP
B-58	RODRIGUEZ Ignacio	2	4	<b>OUELLET Jean-Francois</b>	0 - 10	2:05	WIP
B-63	SARENAC Nedjo	1	3	MCMANUS James			
B-64	<b>RODRIGUEZ Ignacio</b>	2	5	RYGIELSKI Martin	10 - 0	1:50	WIP

## Results/Résultats

Pos	Name/Nom
1	RYGIELSKI Martin, ON
2	MCMANUS James, NB
3	OUELLET Jean-Francois, QC
3	RODRIGUEZ Ignacio, BC